

KARIBAN

REFERENCE : K8003

SIZES : U

COMPOSITION :

Main fabric : Cotton canvas - 320 100%cotton

Fabric 1 : Synthetic fabric - Polyester with PU coating - 290 For belt and brases 100%polyester - Polyurethane coating

WEIGHT :

Main fabric : 320 gsm

Fabric 1 :

ARTICLE WEIGHT :

340 gr/pc

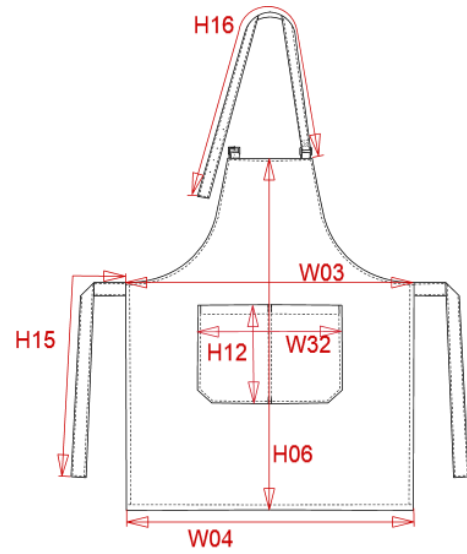

DESCRIPTION
Français : Tablier vintage
English : Vintage apron
Nederlands : Vintage schort
Deutsch : Vintage-Schürze
Español : Delantal vintage
Italiano : Grembiule vintage
Português : Avental vintage

COLORS	PANTONE SERIGRAPHIE
Vintage navy	533C
Vintage charcoal	447C

MEASUREMENT	
Description	U
H06 Hauteur milieu devant / Middle front length	90
W03 Largeur taille / Waist width	76
W04 Largeur bas / Bottom width	81
H12 Hauteur poche / Pocket height	20
W32 Largeur haut de poche devant / Top pocket width	31,50
H16 Longueur bretelle / Braces length	59
H15 Longueur ceinture / Belt length	100

CARE LABEL

PACKING
Box 50 pcs / box U => L:60cm W:40cm H:33cm GW:16.85kg NW:19.4kg